

HALF MASK

34600

EN. USER INSTRUCTIONS

ES. MANUAL DE INSTRUCCIONES

PT. MANUAL DE INSTRUÇÕES

FR. MANUEL D'INSTRUCTIONS

IT. ISTRUZIONI PER L'UTENTE

DE. BEDIENUNGSANLEITUNG

РУ. ИНСТРУКЦИЯ ДЛЯ ПОЛЬЗОВАТЕЛЯ

A. مَدْخَتْ سَمَلَا تَامِي لَعَت

PO. INSTRUKCJE UŻYTKOWNIKA

LI. VARTOTOJO INSTRUKCIJOS

SV. ANVÄNDARINSTRUKTIONER



SAFETOP®

MANUFACTURER | FABRICANTE | FABRICANTE | FABRICANT | PRODUTTORE | HERSTELLER | PRODUCENT | GAMINTOJAS | عَنَامِرِلَا | ПРОИЗВОДИТЕЛЬ | TILLVERKARE

SAFETOP INNOVATIVE PROTECTION SL

R/ O Morrazo, 2 - 15171 (Iñás, Oleiros) A Coruña - SPAIN | Phone: (+34) 981 64 98 11 | Fax: (+34) 981 64 98 12
info@safetop.net | www.safetop.net

EN

HALF MASK RESPIRATOR

WARNING

TPR FACEPIECE. EN140:1998

The TPR respirator 34600 Series is a twin filter half mask respirator which has resistant filter connectors and a form-fitting shape which gives optimum vision.

The 34600 series gives great comfort and a great facefit since it is made of the most advanced TPR technology.

The 34600 series is available in three sizes, 34600 S, M and L.

For the correct use of the respirator, read these instructions carefully before using it and keep this document for further consultation.

I. WARNING

Misuse may result in sickness or death.

1. This respirator does not supply oxygen (O₂). Use in adequately ventilated areas without oxygen deficiency and that do not contain explosive atmospheres.

2. The proper type of filter must be chosen according to concentration and type of contaminant in each case. Do not use in environments where the concentration value of the contaminant is immediately dangerous to life or health (IDLH).

3. Two filters must be placed on each respirator.

4. Must not be used for protection against carbon monoxide under any circumstances.

5. The respirator must not be modified nor altered.

6. This respirator with filters cannot be used in containers, wells, sewers or closed spaces with no ventilation.

7. Do not use with beards or any other elements on the user's face which might prevent the face-fit.

8. Leave the working area in case of respirator being damaged, breathing difficulty and/or dizziness or nausea, or filters unintentionally detachment.

9. Caution must be given in oxygen enriched atmospheres (ignition) and prohibit to enter explosive atmospheres (eg Through solvents).

II. BEFORE USE

1. Make sure the respirator has all its parts: harness and straps, inhalation and exhalation valves.

2. Make sure the respirator is in perfect conditions, with no signs of dirt, breakage, cracks, bumps in any of its components. Should this be the case, the respirator must be disposed off.

3. Make sure that the chosen filter is the proper one for the intended use.

4. Make sure two units of the same type of filter are available for each respirator.

III. ASSEMBLING INSTRUCTIONS

Match the plastic filter connector with the filter-holder on the respirator (figure N°1). Press and turn the filter all the way clockwise (figure N°2). Repeat procedure for the second filter.

IV. INSTRUCTIONS FOR DONNING AND FITTING

1. Adjust the size of the plastic head cradle as necessary so as to fit comfortably on your head.

2. Place the plastic head cradle over your head with the arrow that is on the figure of a face pointing forward.

3. Hold the ends of the bottom elastic straps with one hand and with the other hand slide the facepiece up onto your face covering your mouth and nose. (figure N°3).

4. Grasp the ends of the straps place them at the back of the neck and hook them together. (figure N°4). Adjust strap tension by pulling straps ends until a secure and comfortable fit is obtained. Strap tension may be decreased by pushing out on back side of buckles.

V. FACEFIT CHECK

Positive pressure facefit check

Cover with your hand the exhalation valve, exhale gently to get over-pressure and make sure no air leaks are detected (Figure N°5).

Negative pressure facefit check

• When using with filters A1, A1E1, ABEK1, ABEKP3, A2P3 place hands to cover face of cartridge and inhale (figure N°6). In case of no leakage, you will feel that the respirator is fitted to the face.

• When using with filters serie 700- P3R particulate filters, or P3R particulate filters with nuisance level, press or squeeze filter covers with both hands and inhale (figure N°7). In case of no leakage, you will feel that the respirator is fitted to the face.

• When using with filters serie 200, P3R particulate filters with nuisance level, place the thumbs onto the center position of the filters and inhale (figure N°8). In case of no leakage, you will feel the respirator is fitted to the face.

• If you detect leakage in some of the tests, the respirator has not been fitted to the face properly. If that be the case, reposition respirator on face again, adjusting the elastic straps again and repeat the seal checks.

• If you can not achieve a proper facefit, do not enter contaminated area.

• Consult with an Occupational Safety Expert.

• To remove respirator, loosen up elastic straps, unbuckle bottom straps and remove harness from the head.

VI. STORAGE

Respirator must be stored without the filters in a hermetically sealed bag at room temperature in a dry place away from contaminants. Do not expose respirator to heat over 50°C and do not expose to direct sunlight. Shelf life: 5 years after production (storage under conditions other than those specified by the manufacturer may affect the shelf life).

VII. CLEANING AND DISINFECTION

1. Remove filters before cleaning respirator

2. Clean respirator with a wet cloth and immerse it in warm water solution which must not exceed 50°C using a neutral detergent if necessary.

3. Rinse with warm water and air dry in a contaminant free environment.

DO NOT CLEAN WITH SOLVENTS, STRONG DETERGENTS OR PETROLEUM BASED PRODUCTS.

VIII. MAINTENANCE

In order to keep respirator in the best conditions, do the following after each use:

• Clean and store completely dry in a hermetically sealed bag without filters.

• Check inhalation and exhalation valves and keep them completely clean without any distortions.

• Make sure the elasticity of the straps does not decrease.

• Make sure respirator is in perfect conditions with no signs of dirt, tearing, crack or dents in any of its components.

• If any of its pieces show any distortions the respirator must be replaced and/or disposed off.

IX. EXPIRATION

Respirators 34600 Series are manufactured with high quality materials. However, respirator parts such as valves, harness, straps or any part that needs to be changed, must be replaced the moment they show any alteration or distortion.

X. USE LIMITATIONS

The use of this respirator must be in compliance with current legislation, standards about respiratory protection and standards from various official bodies.

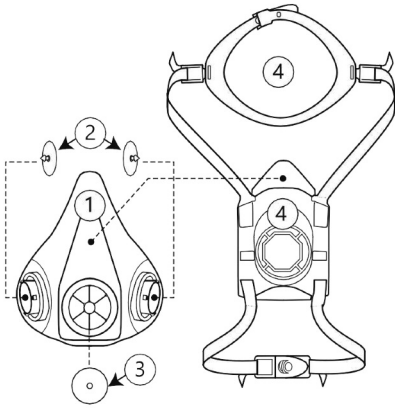

- 1. S, M and L face pieces
- 2. Inhalation valves
- 3. Exhalation valves
- 4. Head straps assembly with front rigid part, elastic bands and hooks

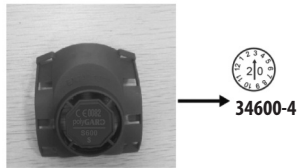
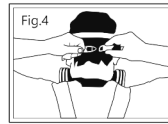
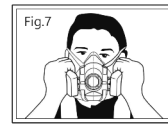
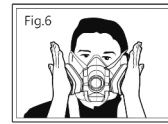
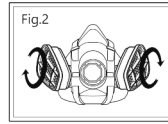
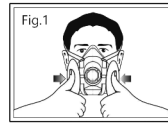

NOTE:
 Above items need to be checked before use.
 As usual use, change them one time less than one year.
 Check before use, when broken or aged, change it.
 If you cannot reach a face fit when doing fit check please change it.



See information supplied by the manufacturer



Storage temperature range



Maximum relative humidity of storage



Manufacture date

